



Inline fan CFI

The **exodraft** CFI type fans are specially designed for heat resistant fans built into ducts.

The **exodraft** CFI fans work at temperatures up to 300 °C on a continuous basis. The fans that are fitted in a durable, low vibration and extremely corrosion resistant stainless steel (316) housing are equipped with a centrifugal impeller made of cast aluminium.

The motor is high temperature resistant, totally enclosed, asynchronous motor

fitted with totally enclosed, maintenance free roller bearings. Its speed is variable by means of a frequency converter or a Triac controller, depending on the model.

It is mounted outside the exhaust gas flow. This construction ensures the fans have a high degree of operational safety and a long working life.

The motor assembly can easily be removed from the apparatus for maintenance and inspection tasks.

Technical data

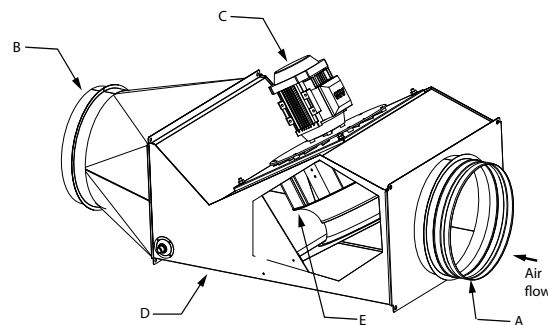

- A. Inlet
- B. Outlet
- C. Motor
- D. Housing
- E. Impeller

Type	Hz	RPM	Motor data			Dimensions					
			V	Amps	kW*	Weight kg	D1 mm	D2 mm	H mm	L mm	W mm
CFI300	50	1350	1 x 230	1,8	0,27	34	303	301	553	1316	539
CFI350	50	1300	1 x 230	2,3	0,45	42,5	353	351	630	1418	619
CFI400	60	1680	3 x 208-230 / 3x440-480**	5,5/2,9	1,4	58	403	401	674	1558	719
CFI500	60	1730	3 x 208-230/3x440-480**	7,8/4,1	2,56	82,5	503	501	766	1813	799

* Max consumption
 Ambient temperature: 20 °C
 RPM is infinitely adjustable. Motor protection class IP 54. Insulation class F
 ** Frequency converter is required
 D1 = Inner diameter
 D2 = Outer diameter

Capacity diagrams

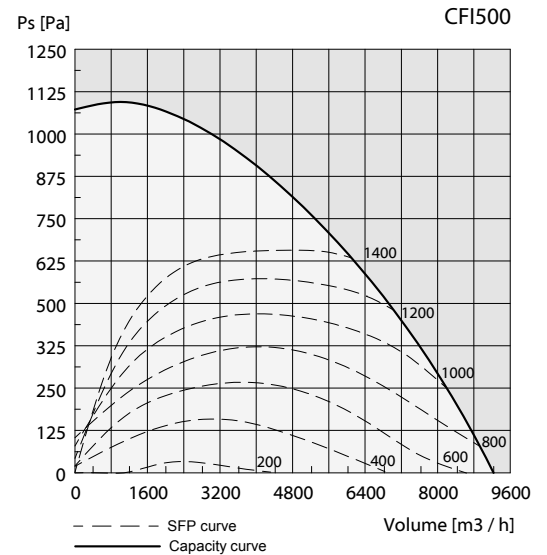
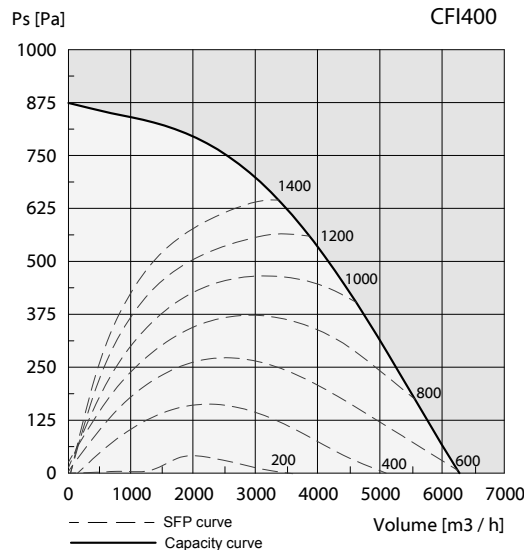
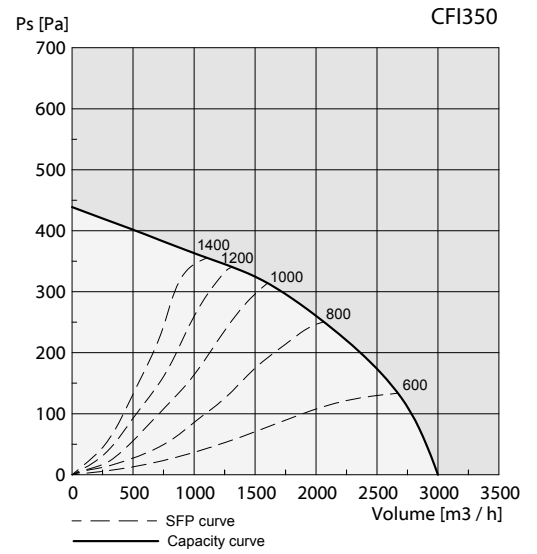
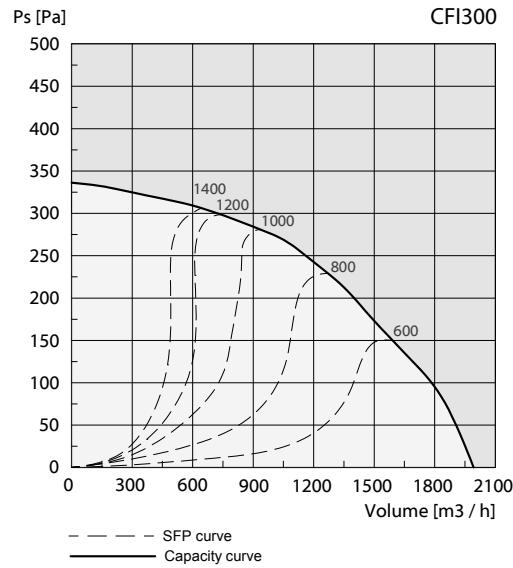

--- SFP curve
 — Capacity curve

SFP

SFP = [joule/m³]
 P1 = consumption [watt]
 V = volume [m³/h]

$$P1 = \frac{SFP \times V}{3600}$$

Capacity curve

The capacity diagrams are measured with a flue gas temperature of 20 °C. The fan's capacity changes with the temperature of the flue gases. The correction of the capacity can be calculated using the following equation:

P_{S_t} = static pressure at a certain temperature (t)
 t = temperature measured in °C
 $P_{S_{20}}$ = static pressure at 20 °C

$$P_{S_{20}} = P_{S_t} \times \frac{(273 + t)}{293}$$

Example:

System demand: 1.800 m³/h and 32 Pa at 180 °C

$$P_{S_{20}} = 32 \times \frac{(273 + 180)}{293}$$

Fan selection: CFI300 1.800 m³/h and 49 Pa at 20 °C

Sound data CFI 300

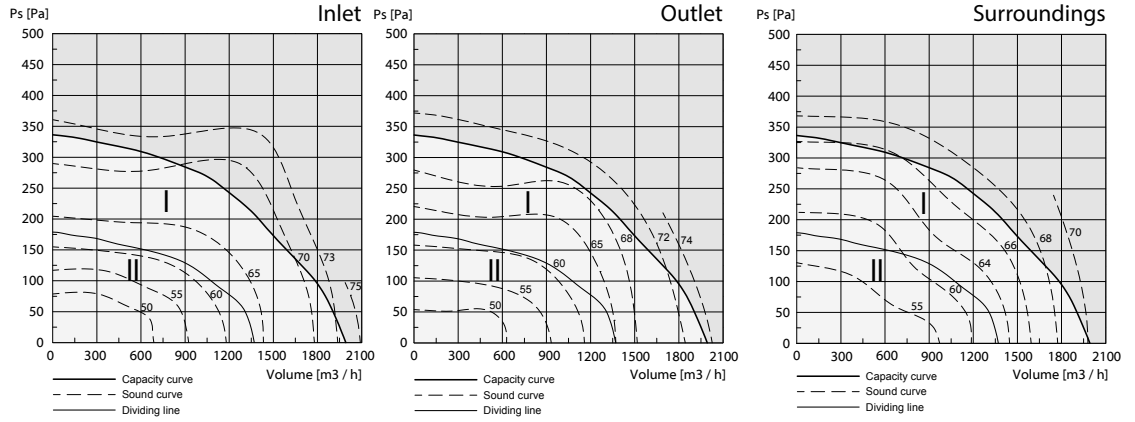

Table 1
Correction factors for calculating sound output in the first octave band to channels and surroundings. [dB]

	Area	63Hz	125 Hz	250 Hz	500 Hz	1000 Hz	2000 Hz	4000 Hz	8000 Hz
Inlet channel (K_w)	I	12	8	4	-5	-9	-11	-11	-17
	II	-15	12	3	-6	-9	-12	-21	-28
Outlet channel (K_w)	I	10	6	3	-5	-6	-9	-11	-16
	II	12	12	3	-7	-7	-11	-21	-27
Surroundings (K_w)	I	0	2	4	-5	-4	-10	-15	-24
	II	5	7	5	-3	-5	-12	-20	-24

Table 2
Correction factors for calculating A-weighted sound pressure to surroundings [dB(A)]

	Area	5m							
Pressure (K_{pA})	I	-22							
	II	-22							

Table 3
Example: Sound power output level for inlet channel [dB] = (Readings in Diagram A) + (Correction factor in Table 1)

	Area	63Hz	125 Hz	250 Hz	500 Hz	1000 Hz	2000 Hz	4000 Hz	8000 Hz
Sound power output to inlet channel in the first octave band (L_{W1})	I	80	76	72	63	59	57	57	51
	II	-	-	-	-	-	-	-	-

Table 4
Example: Sound power output level for outlet channel [dB] = (Readings in Diagram B) + (Correction factor in Table 1)

	Area	63Hz	125 Hz	250 Hz	500 Hz	1000 Hz	2000 Hz	4000 Hz	8000 Hz
Sound power output to outlet channel in the first octave band (L_{W2})	I	79	75	72	64	63	60	58	53
	II	-	-	-	-	-	-	-	-

For the values in **Table 3** is read the factor (L_{WA1}) in **Diagram A** at 2/3 of max. flow. 2/3 of 1975 m³/h = 1317 m³/h
Reading =68

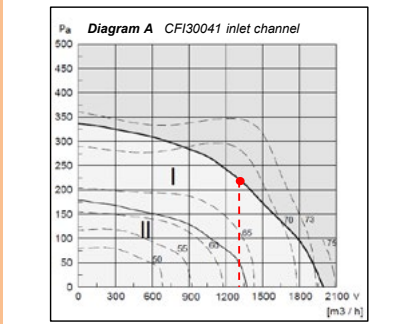

For the values in **Table 4** is read the factor (L_{WA2}) in **Diagram B** at 2/3 of max. flow. 2/3 of 1975 m³/h = 1317 m³/h
Reading =69

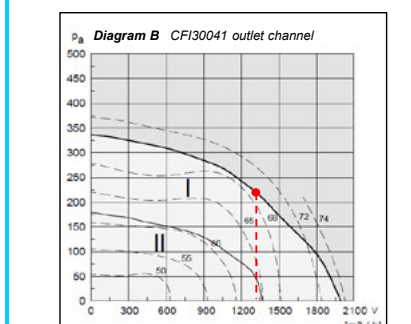

Sound data CFI 300

Table 5

Example: Sound power output level for surroundings [dB] = (Readings in Diagram C) + (Correction factor in Table 1)

Sound power output to surroundings in the first octave band (L_{W3})	Area	63Hz	125 Hz	250 Hz	500 Hz	1000 Hz	2000 Hz	4000 Hz	8000 Hz
I		67	69	71	62	63	57	52	43
II		-	-	-	-	-	-	-	-

Table 6

Example: Sound pressure to surroundings [dB(A)] = (Readings in Diagram C) + (Correction factor in Table 2)
Every time that distance doubles another 6dB is withdrawn. Example: 10m = 67 - 22 - 6 = 39

A-weighted sound pressure in () meters distance (L_{pA3})	Area	5m	10m	20m	40m				
I		45	39	33	27				
II		-	-	-	-				

For the values in **Table 5** and **Table 6** is read the factor (L_{WA1}) in **Diagram C** at 2/3 of max. flow. 2/3 of 1975 m³/h = 1317 m³/h
Reading = 67

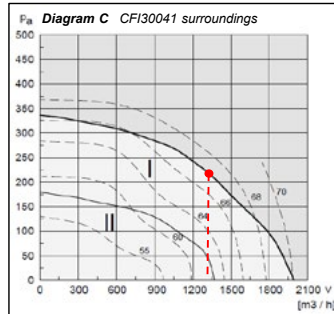

K_{W1} : Correction factor for calculating sound output in the first octave band.
 K_{pA1} : Correction factor for calculating A-weighted sound pressure.

L_{W1} : Sound power output level for inlet channel
 L_{W2} : Sound power output level for the outlet channel
 L_{W3} : Sound power output level to surroundings
 L_{pA3} : Sound pressure level dB(A) at a distance of 10 metres from hemi-spherical sound dissipation in free field and with

I: Upper operating area.
II: Lower operating area.
 L_{WA1} can be read from the curve diagram.

Sound data CFI 350

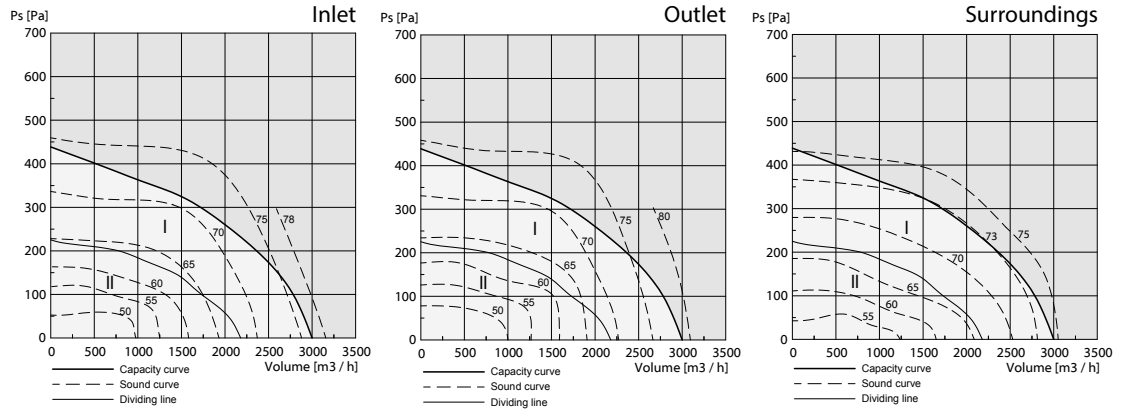

Table 1
Correction factors for calculating sound output in the first octave band to channels and surroundings. [dB]

	Area	63Hz	125 Hz	250 Hz	500 Hz	1000 Hz	2000 Hz	4000 Hz	8000 Hz
Inlet channel (K_{W1})	I	12	9	5	-4	-9	-13	-15	-19
	II	15	12	3	-4	-10	-16	-21	-25
Outlet channel (K_{W2})	I	10	7	4	-6	-6	-12	-16	-19
	II	15	12	1	-5	-7	-14	-21	-24
Surroundings (K_{W3})	I	1	0	-2	-6	-2	-9	-14	-24
	II	4	5	0	-3	-4	-12	-18	-25

Table 2
Correction factors for calculating A-weighted sound pressure to surroundings [dB(A)]

	Area	5m							
Pressure (K_{pA})	I	-22							
	II	-22							

Table 3
Example: Sound power output level for inlet channel [dB] = (Readings in Diagram A) + (Correction factor in Table 1)

	Area	63Hz	125 Hz	250 Hz	500 Hz	1000 Hz	2000 Hz	4000 Hz	8000 Hz
Sound power output to inlet channel in the first octave band (L_{W1})	I	84	81	77	68	63	59	57	53
	II	-	-	-	-	-	-	-	-

Table 4
Example: Sound power output level for outlet channel [dB] = (Readings in Diagram B) + (Correction factor in Table 1)

	Area	63Hz	125 Hz	250 Hz	500 Hz	1000 Hz	2000 Hz	4000 Hz	8000 Hz
Sound power output to outlet channel in the first octave band (L_{W2})	I	83	80	77	67	67	61	57	54
	II	-	-	-	-	-	-	-	-

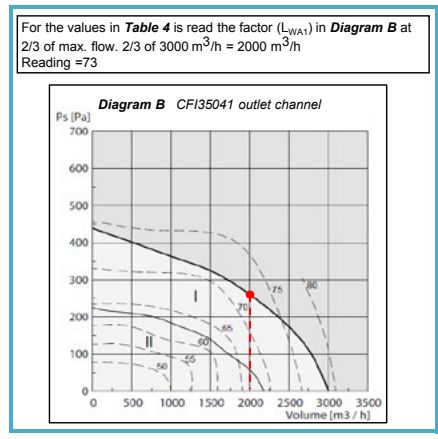
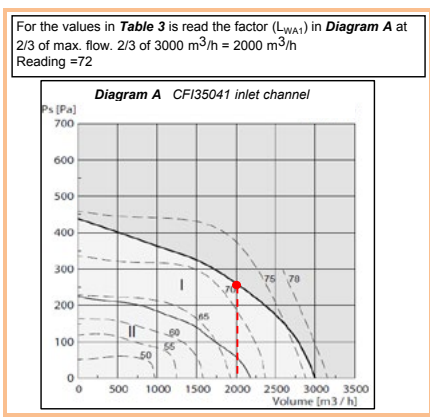

Sound data CFI 350

Table 5

Example: Sound power output level for surroundings [dB] = (Readings in Diagram C) + (Correction factor in Table 1)

Sound power output to surroundings in the first octave band (L_{W3})	Area	63Hz	125 Hz	250 Hz	500 Hz	1000 Hz	2000 Hz	4000 Hz	8000 Hz
I		78	77	75	71	75	68	63	53
II		-	-	-	-	-	-	-	-

Table 6

Example: Sound pressure to surroundings [dB(A)] = (Readings in Diagram C) + (Correction factor in Table 2)
Every time that distance doubles another 6dB is withdrawn. Example: 10m = 73 -22 -6 = 45

A-weighted sound pressure in () meters distance (L_{pA3})	Area	5m	10m	20m	40m				
I		51	45	39	33				
II		-	-	-	-				

For the values in **Table 5** and **Table 6** is read the factor (L_{WA1}) in **Diagram C** at 2/3 of max. flow. 2/3 of 3000 m³/h = 2000 m³/h
Reading = 73

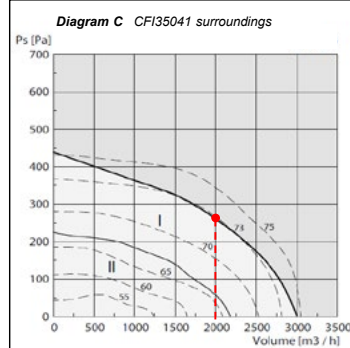

K_{W1} : Correction factor for calculating sound output in the first octave band.
 K_{pA} : Correction factor for calculating A-weighted sound pressure.

L_{W1} : Sound power output level for inlet channel
 L_{W2} : Sound power output level for the outlet channel
 L_{W3} : Sound power output level to surroundings
 L_{pA3} : Sound pressure level dB(A) at a distance of 10 metres from hemi-spherical sound dissipation in free field and with

I: Upper operating area.
II: Lower operating area.
 L_{WA1} can be read from the curve diagram.

Sound data CFI 400

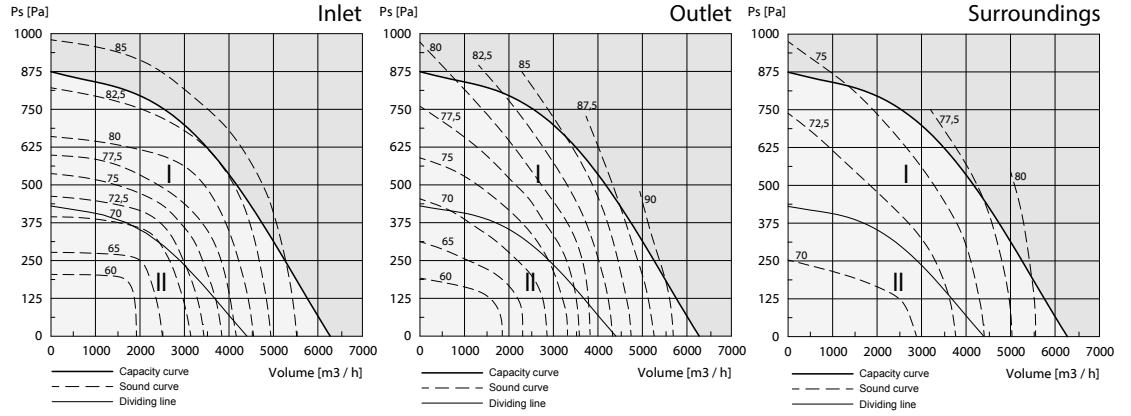

Table 1
Correction factors for calculating sound output in the first octave band to channels and surroundings. [dB]

	Area	63Hz	125 Hz	250 Hz	500 Hz	1000 Hz	2000 Hz	4000 Hz	8000 Hz
Inlet channel (K_w)	I	9	4	3	-4	-6	-8	-16	-23
	II	11	9	2	-3	-6	-12	-19	-27
Outlet channel (K_w)	I	3	0	3	-6	-4	-10	-20	-29
	II	7	7	1	-4	-4	-12	-21	-29
Surroundings (K_w)	I	5	-3	0	-5	-4	-10	-9	-14
	II	-1	-7	-9	-11	-12	-18	-2	-11

Table 2
Correction factors for calculating A-weighted sound pressure to surroundings [dB(A)]

	Area	5 m							
Pressure (K_{pA})	I	-22							
	II	-22							

Table 3
Example: Sound power output level for inlet channel [dB] = (Readings in Diagram A) + (Correction factor in Table 1)

	Area	63Hz	125 Hz	250 Hz	500 Hz	1000 Hz	2000 Hz	4000 Hz	8000 Hz
Sound power output to inlet channel in the first octave band (L_{w1})	I	91	86	85	78	76	74	66	59
	II	-	-	-	-	-	-	-	-

Table 4
Example: Sound power output level for outlet channel [dB] = (Readings in Diagram B) + (Correction factor in Table 1)

	Area	63Hz	125 Hz	250 Hz	500 Hz	1000 Hz	2000 Hz	4000 Hz	8000 Hz
Sound power output to outlet channel in the first octave band (L_{w2})	I	89	86	89	80	82	76	66	57
	II	-	-	-	-	-	-	-	-

For the values in **Table 3** is read the factor (L_{wA1}) in **Diagram A** at 2/3 of max. flow. 2/3 of 6250 m³/h = 4167 m³/h
Reading = 82

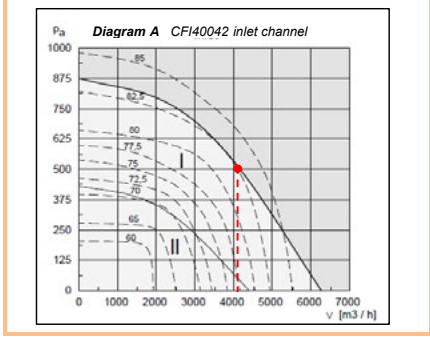

For the values in **Table 4** is read the factor (L_{wB1}) in **Diagram B** at 2/3 of max. flow. 2/3 of 6250 m³/h = 4167 m³/h
Reading = 86

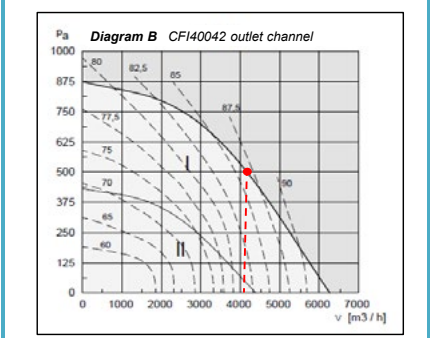

Sound data CFI 400

Table 5

Example: Sound power output level for surroundings [dB] = (Readings in Diagram C) + (Correction factor in Table 1)

Sound power output to surroundings in the first octave band (L_{W3})	Area	63Hz	125 Hz	250 Hz	500 Hz	1000 Hz	2000 Hz	4000 Hz	8000 Hz
	I	82	74	77	72	73	67	68	63
II	-	-	-	-	-	-	-	-	-

Table 6

Example: Sound pressure to surroundings [dB(A)] = (Readings in Diagram C) + (Correction factor in Table 2)
Every time that distance doubles another 6dB is withdrawn. Example: 10m = 77 -22 -6 = 55

A-weighted sound pressure in () meters distance (L_{pA3})	Area	5m	10m	20m	40m				
	I	55	49	43	37				
II	-	-	-	-					

For the values in **Table 5** and **Table 6** is read the factor (L_{WA1}) in **Diagram C** at 2/3 of max. flow. 2/3 of 6250 m³/h = 4167 m³/h
Reading = 77

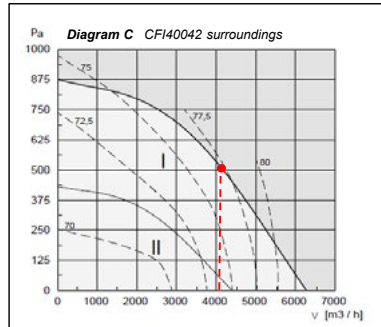

K_{W1} : Correction factor for calculating sound output in the first octave band.
 K_{pA} : Correction factor for calculating A-weighted sound pressure.

L_{W1} : Sound power output level for inlet channel
 L_{W2} : Sound power output level for the outlet channel
 L_{W3} : Sound power output level to surroundings
 L_{pA3} : Sound pressure level dB(A) at a distance of 10 metres from hemi-spherical sound dissipation in free field and with

I: Upper operating area.
II: Lower operating area.
 L_{WA1} can be read from the curve diagram.

Sound data CFI 500

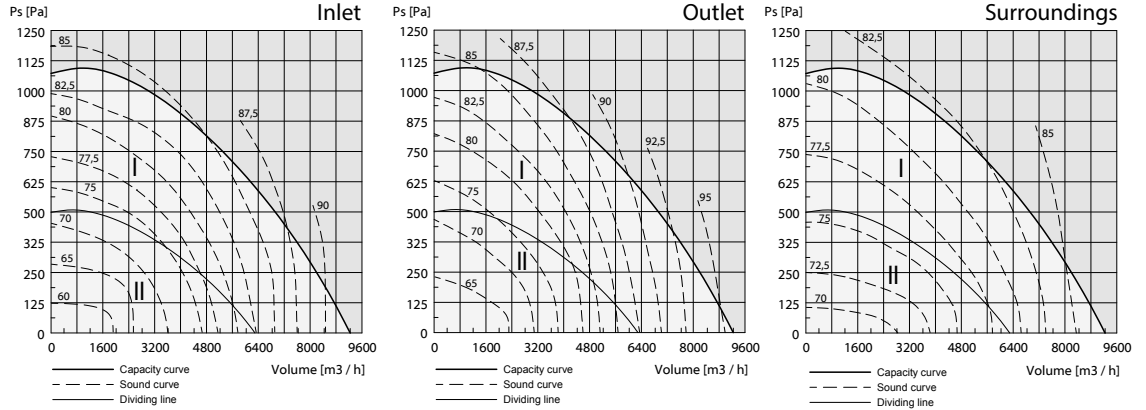

Table 1
Correction factors for calculating sound output in the first octave band to channels and surroundings. [dB]

	Area	63Hz	125 Hz	250 Hz	500 Hz	1000 Hz	2000 Hz	4000 Hz	8000 Hz
Inlet channel (K_W)	I	9	2	5	-5	-9	-11	-15	-22
	II	9	10	4	-4	-10	-13	-17	-24
Outlet channel (K_W)	I	3	-3	3	-7	-3	-13	-19	-26
	II	4	8	0	-6	-3	-14	-18	-26
Surroundings (K_W)	I	4	-1	-1	-3	-5	-11	-10	-13
	II	-2	-5	-7	-7	-11	-16	-2	-11

Table 2
Correction factors for calculating A-weighted sound pressure to surroundings [dB(A)]

	Area	5m
Pressure (K_{pA})	I	-22
	II	-22

Table 3
Example: Sound power output level for inlet channel [dB] = (Readings in Diagram A) + (Correction factor in Table 1)

	Area	63Hz	125 Hz	250 Hz	500 Hz	1000 Hz	2000 Hz	4000 Hz	8000 Hz
Sound power output to inlet channel in the first octave band (L_{W1})	I	95	88	91	81	77	75	71	64
	II	-	-	-	-	-	-	-	-

Table 4
Example: Sound power output level for outlet channel [dB] = (Readings in Diagram B) + (Correction factor in Table 1)

	Area	63Hz	125 Hz	250 Hz	500 Hz	1000 Hz	2000 Hz	4000 Hz	8000 Hz
Sound power output to outlet channel in the first octave band (L_{W2})	I	94	88	94	84	88	78	72	65
	II	-	-	-	-	-	-	-	-

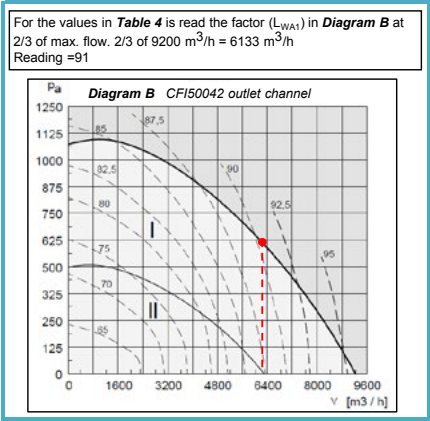
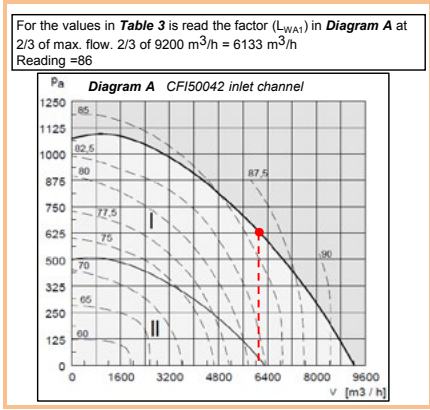

Sound data CFI 500

Table 5

Example: Sound power output level for surroundings [dB] = (Readings in Diagram C) + (Correction factor in Table 1)

Sound power output to surroundings in the first octave band (L_{W2})	Area	63Hz	125 Hz	250 Hz	500 Hz	1000 Hz	2000 Hz	4000 Hz	8000 Hz
I		87	82	82	80	78	72	73	70
II		-	-	-	-	-	-	-	-

Table 6

Example: Sound pressure to surroundings [dB(A)] = (Readings in Diagram C) + (Correction factor in Table 2)
Every time that distance doubles another 6dB is withdrawn. Example: 10m = 83 - 22 - 6 = 55

A-weighted sound pressure in () meters distance (L_{pA3})	Area	5m	10m	20m	40m				
I		61	55	49	43				
II		-	-	-	-				

For the values in **Table 5** and **Table 6** is read the factor (L_{WA1}) in **Diagram C** at 2/3 of max. flow. 2/3 of 9200 m³/h = 6133 m³/h
Reading = 83

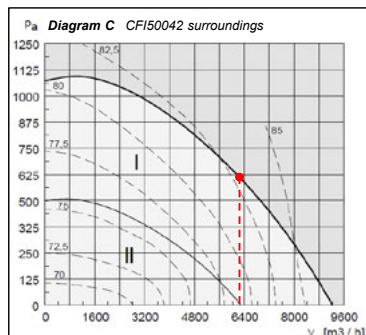

K_{W1} : Correction factor for calculating sound output in the first octave band.
 K_{pA} : Correction factor for calculating A-weighted sound pressure.

L_{W1} : Sound power output level for inlet channel
 L_{W2} : Sound power output level for the outlet channel
 L_{W3} : Sound power output level to surroundings
 L_{pA3} : Sound pressure level dB(A) at a distance of 10 metres from hemi-spherical sound dissipation in free field and with

I: Upper operating area.
II: Lower operating area.
 L_{WA1} can be read from the curve diagram.